

KOMMA

Steigern Sie Ihre Markenpräsenz mit
speziell für die Landwirtschaft
entwickelten Werbeartikeln.
Von Regenschirmen über
Thermometer bis hin
zu Trichtern und
Messbechern,
unsere
Produkte
sind
darauf

ausgerichtet,
Ihre Marke
auf dem Feld und
darüber hinaus
wachsen zu lassen.

www.Komma-Agentur.com | Tel. +49 / 39204 / 92799-0



TABLE OF CONTENTS

p. 3

Techniques used for printing

p. 4

Spoons

p. 7

Measures

p. 12

Scoops

p. 14

Buckets

p. 18

Yellow TRAP

p. 20

Rain Gauges

p. 23

Measuring quadrats

p. 24

Thermometer SOIL

p. 26

Thermometer Thermo

p. 27

Cleaning brush Nozzle+

p. 28

Knife Lizard

p. 28

Dial caliper MIL+

p. 28

Oil can JUMBO

SIGNS & SYMBOLS



total height [mm]



overall width [mm]



total length [mm]



diameter [mm]



total volume [ml]

LOGO

marking area (width * height) [mm]



print possible in various colours



product with scale (printed or embossed)

product available in other colours
on requestproduct approved for food contact
(BPA free)

MAX 95°C

the product is dishwasher safe at the
specified maximum temperature (°C)

suitable for use in the microwave oven



recycled product (granulate)

polypropylene, a product of the safe plastic
group (recyclable)polyethylene, a product of the safe plastic
group (recyclable)

product for multiple use

carton, number of items per carton [pcs.]
quantity for Poland/ quantity for Europe

pallet, number of items per pallet [pcs.]

certyfiat Prüfinsitut Chemische Analytik
GmbH

TECHNIQUES USED FOR PRINTING

SCREEN PRINTING

The only method for permanent printing on plastics which allows products printed with this technique to be used in the agricultural, chemical, construction and food industries. Our screen printing ink's are dishwasher safe, resistant to chemicals and abrasion. Its advantage is the ability to print permanently without colour limitation, on any surface size (flat and convex).

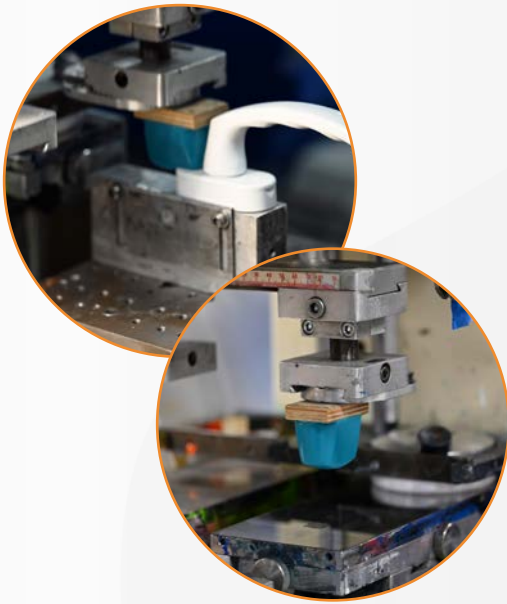

PAD PRINTING

A method of permanent and fast printing on plastics, which allows products printed with this technique to be used in the agricultural, chemical, construction and food industries. This printing technique is recommended for small products with a flat, small area printing with a small number of colours.

We test the adhesion of the prints according to standards: **ISO 2409** or **ASTM D3359-B** **DIN 53151**.

We test the abrasiveness of the print according to the standard: **ASTM D5264**.





SPOONS

WHERE CAN YOU USE OUR SPOONS?

- animal nutrition
- pharmaceutical industry
- poultry farms
- food supplements
- food industry
- markets
- agriculture
- restaurants

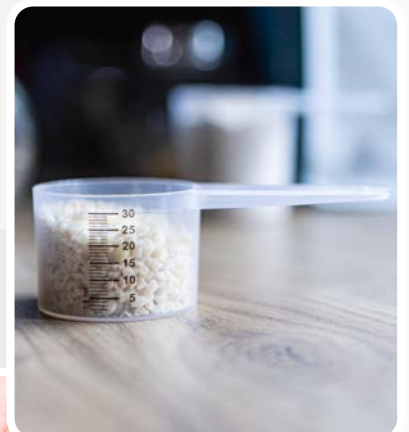

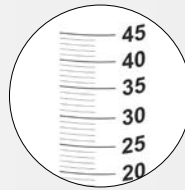

precise scale



individual scales



logo printing possible





convenient spoon packing



spoons in Your colour

FAMILY PIKO

COLORS:     * minimum order min. 20 000 pcs.

White Black Orange Other

PIKO 1 ml

PIKO0001



PIKO 2 ml

PIKO0002



PIKO 5 ml

PIKO0005



PIKO 10 ml

PIKO0010



PIKO 20 ml

PIKO0020



FAMILY PIKO-S

PiCA
Prüfinstitut
Chemische Analytik GmbH

COLORS:   * minimum order min. 20 000 pcs.

Transparent Other

PIKO-S 30 ml

PIKO0030



PIKO-S 50 ml





PIKO0050



PIKO-S 75 ml

PIKO0075



art. no	art. name	↑↓	↔	↔	⊘	📏	LOGO	☑	📦 PL/Europa	🔧	specifications
PIKO0001	PIKO 1 ml	6	18	91	18	-	35 x 6	-	15000 / 12000	160000	    
PIKO0002	PIKO 2 ml	10	22	94	22	-	35 x 7	-	11000 / 10000	112000	
PIKO0005	PIKO 5 ml	14	30	100	30	-	35 x 8	-	8000 / 5500	80000	
PIKO0010	PIKO 10 ml	18	36	106	36	-	40 x 8	-	6000 / 4000	56000	
PIKO0020	PIKO 20 ml	22	45	115	45	-	40 x 9	-	3000 / 2500	36000	
PIKO0030	PIKO-S 30 ml	30	42	90	42	35	30 x 10	✓	2250 / 1500	21600	
PIKO0050	PIKO-S 50 ml	38	46	93	46	50	30 x 11	✓	1700 / 1300	16000	
PIKO0075	PIKO-S 75 ml	51	48	95	48	75	30 x 11	✓	1200 / 900	12000	



MEASURES

WHERE CAN YOU USE OUR SPOONS?

- animal nutrition
- construction industry
- food industry
- agriculture
- beauty industry
- events, trade fairs
- advertisement
- catering
- horticulture
- chemical industry





ask about measure cups in Your colour



gold and silver printing possible



chemical resistant prints



possibility to print your own logo



precise scale



individual scales



economical packaging



liquid / Loose products



possibility of labelling with a barcode



LOG

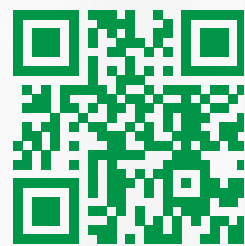

MEASURES



FAMILY NANO

Measures NANO 150 ml / 200 ml / 400 ml



N000150



N000200



N000400

art. no	art. name	↑↓	↗↘	↔	∅	📏	LOGO	☑	📦 PL/Europa	📦	specifications
N000150	NANO 150 ml	107	59	59	59	200	170 x 60	✓	1190 / 924	12480	
N000200	NANO 200 ml	110	66	66	66	270	160 x 80	✓	1134 / 912	12672	
N000400	NANO 400 ml	133	79	79	79	490	220 x 100	✓	650 / 525	6048	

FAMILY SMART

Measures SMART 500 ml

MS00500



Measures SMART 1000 ml

MS01000



Measures SMART 1500 ml

MS01500



Measures SMART 2000 ml

MS02000



Measures SMART 3000 ml

MS03000



PiCA
Prüfinstitut
Chemische Analytik GmbH

art. no	art. name	↑↓	↔	↔	⊘	📏	LOGO	☑	📦 PL/Europa	📦	specifications
MS00500	SMART 500 ml	148	98	140	98	730	130 x 60 / 2	✓	460 / 270	4592	
MS01000	SMART 1000 ml	183	122	175	122	1390	160 x 60 / 2	✓	210 / 144	2000	
MS01500	SMART 1500 ml	201	133	190	133	1800	170 x 60 / 2	✓	143 / 100	1440	
MS02000	SMART 2000 ml	215	142	198	142	2200	190 x 60 / 2	✓	100 / 64	1216	
MS03000	SMART 3000 ml	256	170	230	170	3750	200 x 80 / 2	✓	60 / 36	576	

Measures MUG 500 ml

M000500



Measures EKO 1000 ml

M001000



Measures TWIN 2000 ml

MT02000



Measures SOLID 1800 ml

M001800



Measures GUSTAV 5000 ml

MG05000



Possibility of printing on the handle

Measures BUCK 10 l

WM00010



HANDLES COLOURS:



art. no	art. name	↑↓	↔	↔	∅	📏	LOGO	☑	📦 PL/Europa	📏	specifications
M000500	MUG 500 ml	98	92	130	92	580	180 x 80	✓	144 / 120	1680	
M001000	EKO 1000 ml	134	124	184	124	1230	100 x 85 / 2	✓	150 / 96	1344	
MT02000	TWIN 2000 ml	187	173	177	-	2080	130 x 90	✓	35 / -	500	
M001800	SOLID 1800 ml	201	126	211	126	1900	135 x 85	✓	60 / -	768	
MG05000	GUSTAV 5000 ml	269	208	276	208	6450	200 x 120	✓	42*	400	
WM00010	BUCK 10 l	245	296	274	274	10000	250 x 150	✓	-	1000	

*handle without assembly



convenient packing

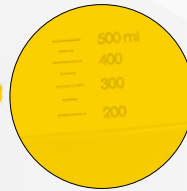

scale on both sides



stable bottom



possibility to print your logo



hanging hole



FAMILY ARTHUR

Scoops Arthur 200 g

ARTHUR200



- COLORS:** * * * * **

* minimum order 1000 pcs.
** individual order

Scoops Arthur 500 g

ARTHUR500



- COLORS:** * * * * **

* minimum order 1000 pcs.
** individual order

Scoops Arthur 1000 g

ARTHUR1000



- COLORS:** * * * * **

* minimum order 1000 pcs.
** individual order

Scoops MEGA+ 2 kg

MEGA2000



- COLORS:** *

* individual order

Scoops MEGA+ 2 kg (two-color)

MEGA2001



- COLORS:** *

* individual order



- strong handle
- economical packaging (handle separately)
- after installing the handle inability to remove it

art. no	art. name	↑↓	↔	↔	⊘	📏	LOGO	☰	📦 PL/Europa	📦	specifications
ARTHUR200	ARTHUR 200 g	39	67	198	-	-	40 x 18	✓	600	8000	
ARTHUR500	ARTHUR 500 g	56	93	251	-	-	45 x 19	✓	300	4800	
ARTHUR1000	ARTHUR 1000 g	70	110	312	-	-	65 x 20	✓	160	2240	
MEGA2000	MEGA+ 2 kg	84	137	340	-	-	112 x 60 + 70 x 30/2	✓	180* 63	1760* 640	
MEGA2001	MEGA+ 2 kg (dwukolorowa)	84	137	340	-	-	112 x 60 + 70 x 30/2	-	180* 63	1760* 640	

* handle without assembly



BUCKETS

WHERE CAN YOU USE OUR BUCKETS?

- animal feeding
- construction industry
- events, trade fairs
- advertisement
- social campaigns
- horticulture
- agriculture
- cleaning companies
- chemical industry
- beauty industry





safety internal handles



trade-Fairs advertisement



recykling
12 l / 16 l / 20 l



embossed scale inside the bucket



colourful prints around the bucket



possibility to print QR-codes



highly durable
12 l / 16 l / 20 l

BUCKETS



EKO 5 l / 10 l









Handle SOFT GRIP 10 l / 12 l / 16 l / 20 l

M001000



W00D005





W00D010

COLORS:         *

Transparent White Red Green Blue Orange Black Other *

* minimum order quantity 5000 pcs.



art. no	art. name	↑↓	↙↘	↔	⊙	📄	LOGO	☰	📦 PL/Europa	🔧	specifications
W000005	EKO 5 l	202	247	231	231	5350	200 x 120 / 2	✓	-	1000	 
W000010	EKO 10 l	245	296	274	274	10000	250 x 150 / 2	✓	-	1000	
M001000	Handle SOFT GRIP 10 l / 12 l / 16 l / 20 l	16	11	105	-	-	-	-	1000	-	 

STRONG 12 l / 16 l / 20 l



W00C12

W00C16

W00C20



COLORS: White Other*

* order W00C12 min. 5000 pcs.
* order W00C16 min. 3000 pcs.
* order W00C20 min. 3000 pcs.

STRONG RECYKLING 12 l / 16 l / 20 l



W00CR12

W00CR16

W00CR20



The strength of buckets STRONG

96 kg

COLORS: Black Blue Green

Bucket LID 12 l

LIDBLACK



COLORS: White Black

STRONG with funnel 12 l

W00CR12L

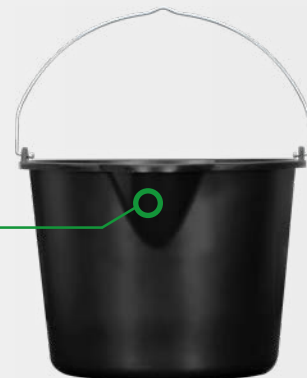
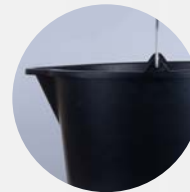

COLORS: Black

art. no	art. name	↑	↗	↔	⊘	🗑️	LOGO	☰	📦 PL/Europa	🔧	specifications
W00C12	STRONG KOLOR 12 l	243	315	309	309	12000	300 x 140 /2	✓	-	1000	
W00C16	STRONG KOLOR 16 l	283	359	330	330	16000	300 x 150 /2	✓	-	720	
W00C20	STRONG KOLOR 20 l	288	394	357	357	20000	350 x 170 /2	✓	-	540	
W00R12	STRONG RECYKLING KOLOR 12 l	243	315	309	309	12000	300 x 140 /2	✓	-	1000	
W00R16	STRONG RECYKLING 16 l	283	359	330	330	16000	300 x 150 /2	✓	-	720	
W00R20	STRONG RECYKLING KOLOR 20 l	288	394	357	357	20000	350 x 170 /2	✓	-	540	
W00CR12L	STRONG RECYKLING 12 l BLACK (with funnel)	240	318	333	309	-	300 x 150 + 300 x 70	✓	-	800	
LIDBLACK	BUCKET LID 12 l	-	295	295	295	-	-	-	114 / 98	1440	



Yellow TRAP-01

TRAP010



SET CONTAINS:



Yellow TRAP-02

TRAP020



SET CONTAINS:

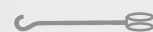

mounting bracket
on the tube/rod
Ø 20-24 mm

Yellow TRAP-03 PREMIUM

TRAP030P



SET CONTAINS:



yellow vessel



mounting bracket on the tube/rod Ø 20-24 mm



folding stick 160 cm



connector 3 pcs.

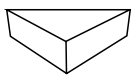

triangular box



Principles of use:

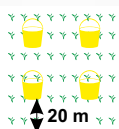

The vessel should be placed on the field just after seeding rapeseed in autumn and after the last snow melts in the spring. Install it approximately 20 m from the field edge, always at the level of the plants' top. It is recommended to use at least four vessels for each plantation.



woda + plyn

Pour water with a bit of dishwashing detergent up to the half of the vessel's height. The addition of the detergent will reduce the surface tension of water which will make the pests immerse in it easier.



Monitor the vessel daily, i.e. count the immersed pests and read the pest limit threshold on the table printed on the vessel. Replace water in the vessel each time.

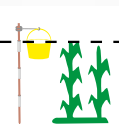

The yellow vessel should be installed on a stick and raised with the growth of rapeseed.

After exceeding the pest limit threshold, decide whether you want to spray the field.

The yellow vessel helps to diagnose the level of harmfulness done by such insects as: ceutorrhynchus, meligethes aeneus and dasineura brassicae.

Grid TRAP NET

TRAPNET1



Grid protecting Bee

SET CONTAINS:



grid TRAP



3 indicators

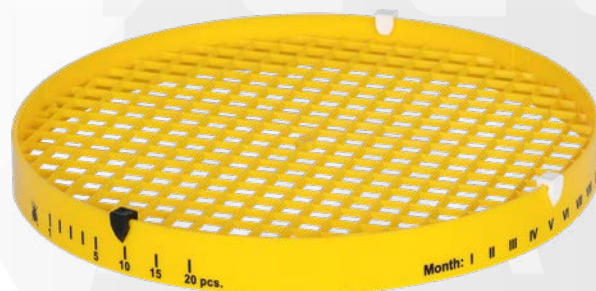



Rain gauge RAIN - EKO

D000001E

Rain gauge RAIN - STANDARD

D000001S



SET INCLUDES:



rain gauge



stick-mount fixture



packaging



SET INCLUDES:



rain gauge



stick-mount fixture



adder's indicators



packaging



RAIN GAUGES

Rain gauge RAIN - PREMIUM

000001P



SET INCLUDES:

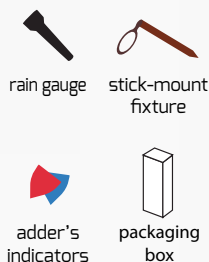

Features:

- vertical scale up to 40 mm with accuracy to 0.5 mm
- expanded scale to 70 mm
- two indicators of the adder (in different colours) allowing to register precisely weekly, monthly and yearly rainfalls
- the adder allows to register the summary rainfall up to 250 mm (250l/m²)
- cone construction of the mounting ring guaranteeing the optimum setting of the rain gauge against the falling rain
- rain gauge protected with patent no (P.218270)
- box of rain gauge protected with industrial design no 18572
- imprint protected with EUIPO no 008303481-0001
- possibility to make any additional imprint

Rain gauge RAIN - FOLD PREMIUM+

DFOLD3R0



SET INCLUDES:

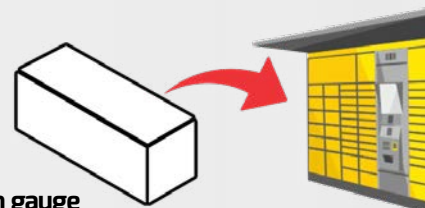

RAIN FOLD rain gauge with a folding stick in the box facilitating further distribution



Rain Gauges FOLD

ADDER'S INDICATORS

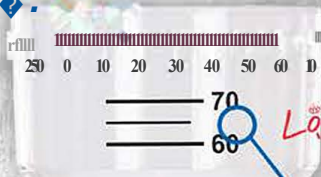

EXTENDED SCALE FOR INTENSIVE ANDSTORM RAINFALL

ADDER'S INDICATORS DAYIMONTH

STYLISH PACKAGING GREAT AS PROMOTIONAL PRESENT

FOLDING PLASTICK STICK



Ask about the packaging sleeve with your design



RAIN GAUGE with a folding stick in the box facilitating further distribution

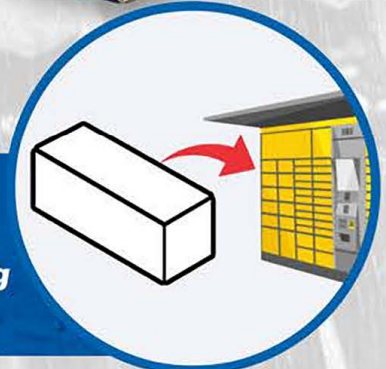

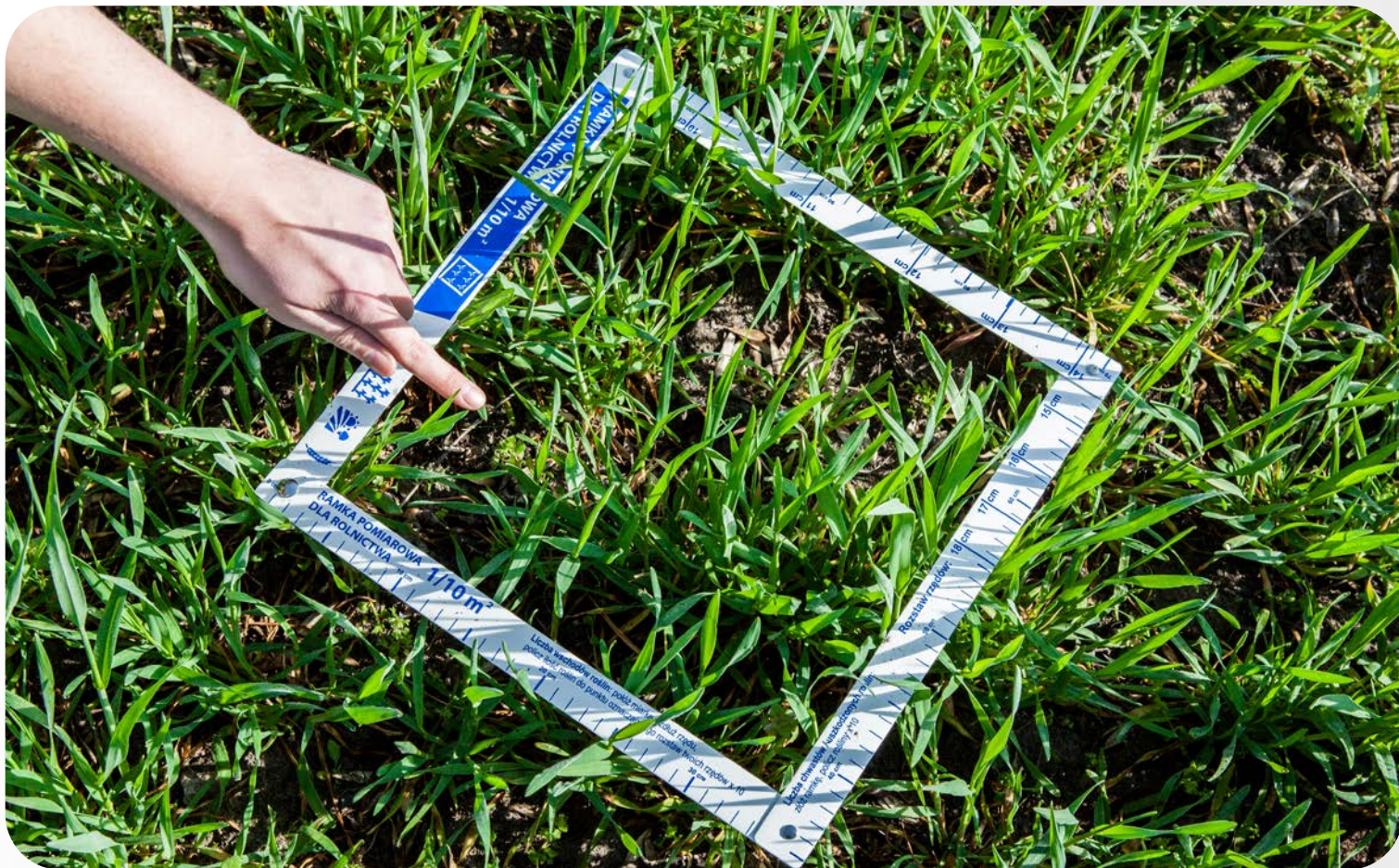

Frame Standard 1/10 m²

RAM0010S

Frame Mega 1/4 m²

RAM0010M

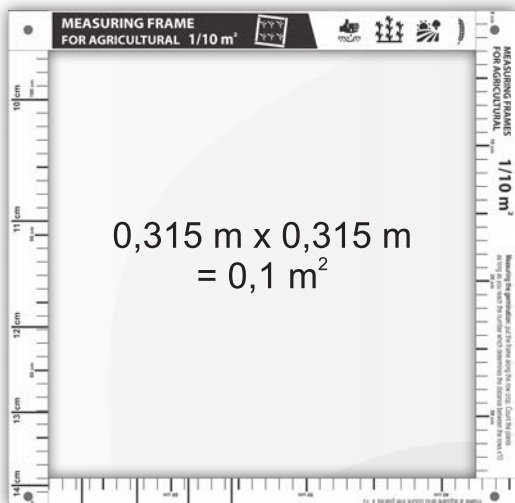

Principles of use:



Measuring the germination:

Put the frame along the row crop. Count the plants as long as you reach the number which determines the distance between the rows. The result has to be multiplied x10. Repeat the measurement in several places and calculate the average. The measurement of germination helps to make the decision about the re-sowing.



Measuring the damaged crops and the number of weeds:

Make a square and count the plants inside the frame. The result has to be multiplied x10. Repeat the measurement in several places and calculate the average. The determination of the number of damaged plants helps not only the framers but also the hunters to specify the damages caused by the wild animals. Measuring frame has the same function by the farmers insurances.





Thermometer SOIL - EKO

T000001E

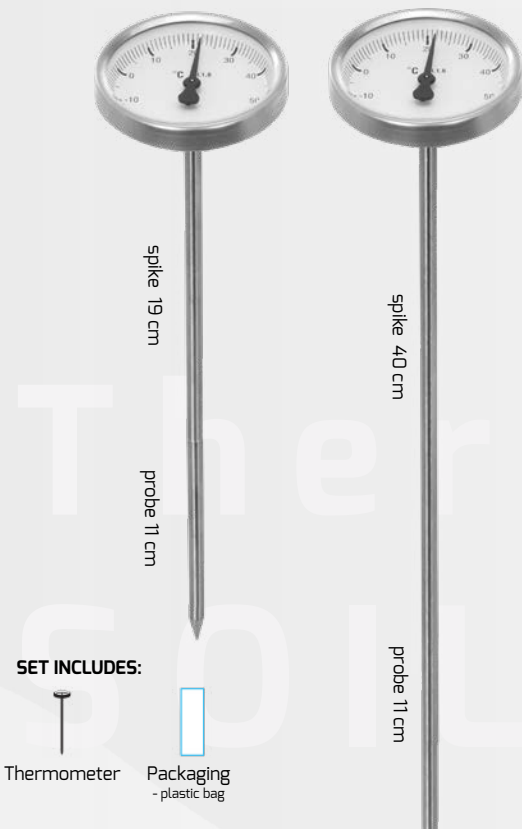

Thermometer SOIL - STANDARD (with a mounting bracket)

T000002S



Thermometer SOIL - PREMIUM / PREMIUM PRO

T00003P

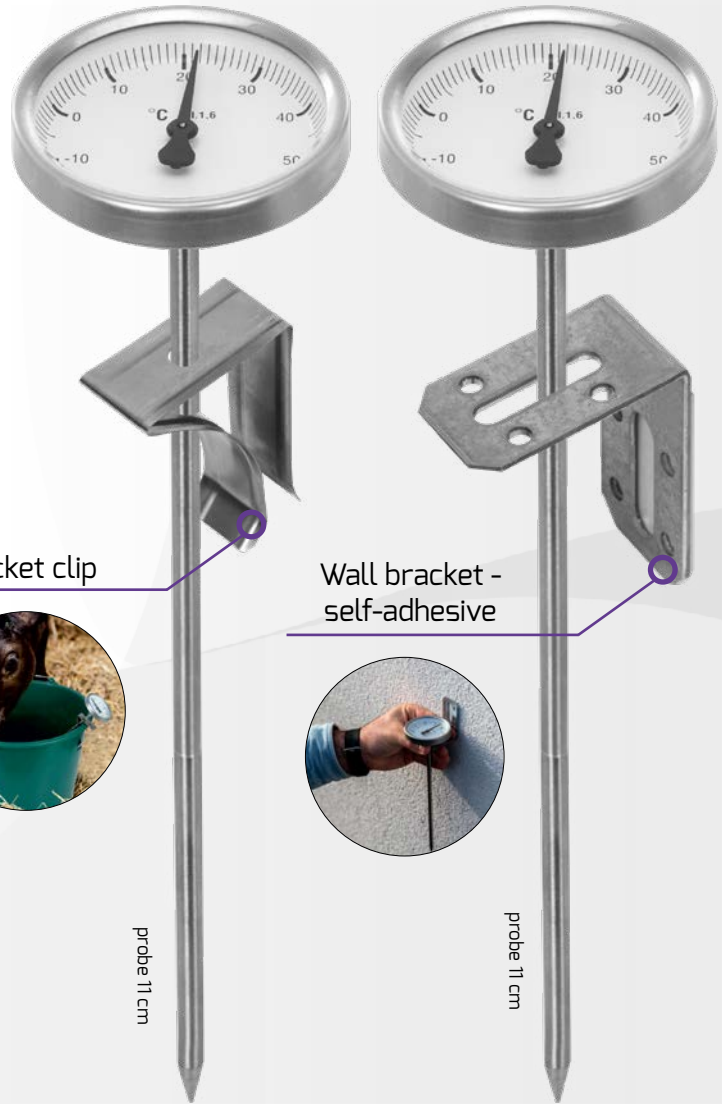

bucket clip

Wall bracket - self-adhesive

probe 11 cm

probe 11 cm



THE PREMIUM SET INCLUDES:

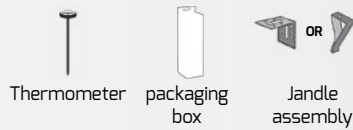

THE PREMIUM PRO SET INCLUDES:

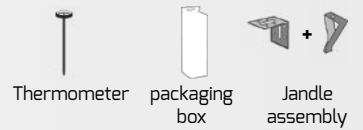

Soil temperature



Temperature of water



Air temperature



Mounting bracket



Handle for mounting on the bucket



Thermometers for measuring soil, liquids and silage thermometers with a longer needle. Farmer's thermometers are practical measuring instruments necessary in every farm. Agricultural thermometers also available with the logo.



Thermometer Thermo 19/27

THERMO1



Set includes:



Thermometer

Stand

Box

Stylish thermometer for indoor use. It comes with a collapsible stand so that the thermometer can be placed anywhere, for example on a desk. The thermometer also has a hole that allows you to hang it on the wall. Recommended comfort zone temperatures: winter 19°C, summer 27°C.